

10 YEAR MANUFACTURER'S LIMITED WARRANTY

All parts of this Kingston Brass faucet are warranted to the original retail purchaser to be free from defects in material and workmanship for a period of Ten(10) years from the date of purchase as shown on the purchaser's receipt.

This warranty is limited to defective parts only, labor charges and/or damage resulting from improper installation, repair or replacements, as well as incidental and consequential damages connected therewith are excluded.

Any damage to this faucet as a result of misuse, abuse, neglect, accident, or improper installation or any use not consistent with the instructions furnished by us, will void this warranty. Replacement parts can be obtained from your local dealer. Freight cost is not covered by manufacturer.

CAUTION!!!

1. Water lines must be completely flushed before use, to avoid debris & clogs in your water system leading to reduction of water flow and mal-functioning.
2. Warranty is void if water lines are not flushed prior to use and installation of the new faucet.
3. Use of abrasives of any strength may damage the finish of the faucet and void the product warranty.
4. Do not over tighten your faucet on the countertop during installation. The valve assembly is tested to meet the standards set by ASME A112.18.1 sec 5.8 which is listed at 100 LBF. However, over-tightened or over-torqued nuts may lead to cracks on the valve and will eventually lead to leaking and water damage.
5. Before installation of the faucet to the desired fixture, you need to secure and anchor your console, sink, tub, or vanity cabinet firmly to the wall and to the floor. To ensure your fixture or faucet mounting surface cannot be moved, before installation of the faucet, please test to see if the cabinet or vanity can be moved by hand or body weight. If the faucet mounting fixture is not secure and anchored, it will eventually crack the valve and cause leaking leading to property damage. In order to avoid this, be sure to secure your installation surface. Do not use any Power Tools for assembly and installation which can cause internal fractures to the fixture.

KINGSTON

KITCHEN & BATH

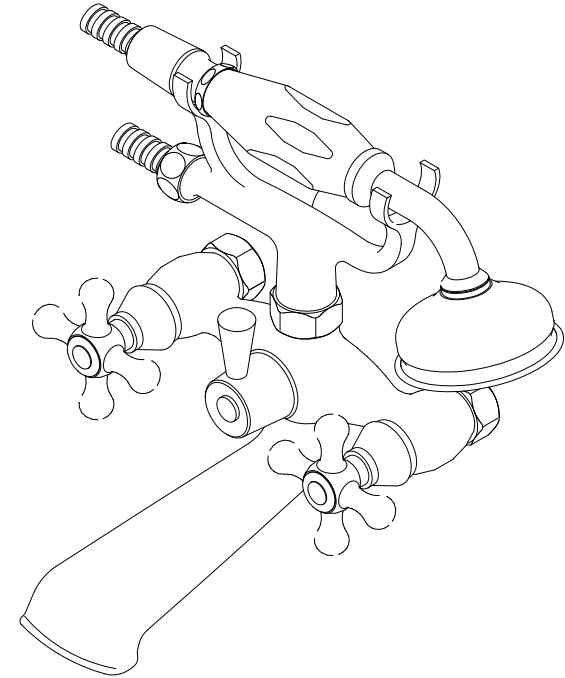

PROBLEMS SHOOTING

PROBLEM	CAUSE	CORRECTIVE ACTION
Leaks underneath handle	Bonnet nut has come loose	Remove the handle and tighten the bonnet nut
Leaks from the spout	Valve seat and spring are worn	Replace the valve seat and spring
Inconsistent water flow pattern	Aerator is dirty or aged	Release aerator and check on rubber gasket if aged or replace with a new aerator
Faucet is dirty	Caused by stubborn water spot	Clean with mild soap and warm water as often as possible
Handles work backward	Handle installed backward	Rotate the right stem stop assembly 180 degrees

www.kingstonbrass.com
 TOLL-FREE CUSTOMER SERVICE: 1-877-2-KBRASS
 TECHNICAL SUPPORT E-mail: service@kingstonbrass.com
 12775 Reservoir Street, Chino, CA 91710

CODE APPROVAL: LA#M-000018

KINGSTON

KITCHEN & BATH

INSTALLATION INSTRUCTIONS

Tub Filler With Hand Shower

BEFORE BEGINNING INSTALLATION

1. Flush plumbing lines to clear any debris.
2. Shut off both supply lines after flushing.

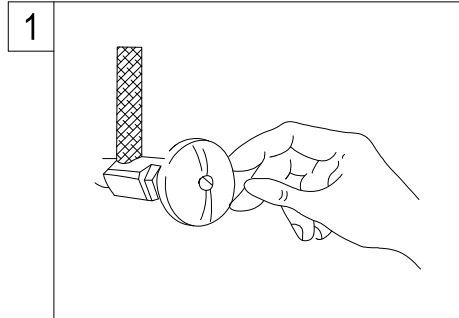

1. Shut off main water supply valve before installation.

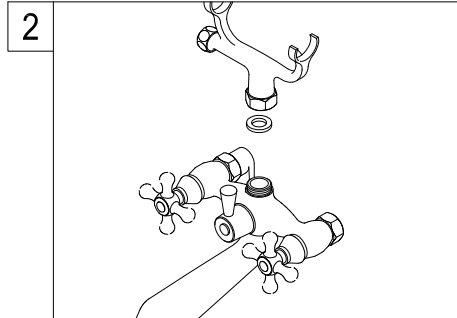

2. Install the shower cradle on top of faucet body.

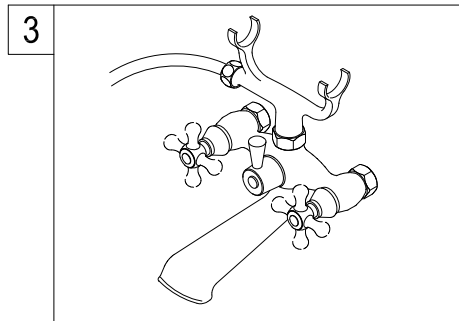

3. Place a washer between the side hole of the shower cradle and the cone nut of the shower hose. Tighten the cone nut.

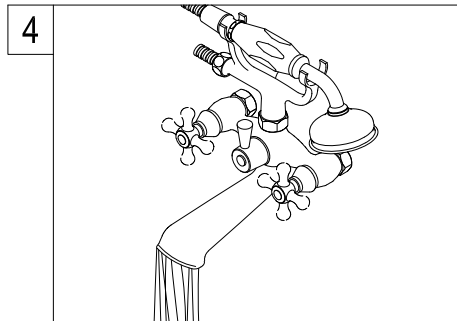

4. Turn on both hot and cold valves, let water run for at least one minute, this will clear any debris left in the line.

Need Tools:

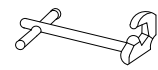

Basin Wrench



Adjustable Wrench



Teflon Tape

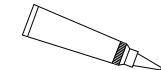

Silicone Sealant

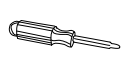

Screwdriver

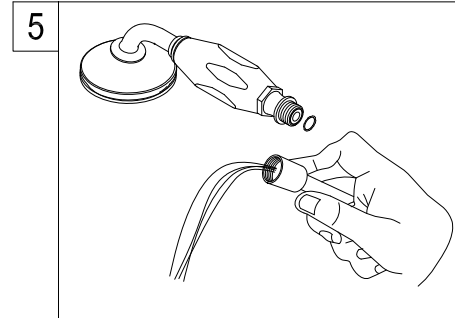

5. Remove shower by unscrewing the shower in a counter clockwise direction, turn on both hot and cold valves and let water run for at least one minute, this will clear any debris left in the line.

Warning!!!

- **DO NOT STEP ON faucet or supply line installation.** This fixture is not a stair to access your storage, window or access higher ceiling. This Cast Brass Faucet cannot support your body weight. To step on faucet will crack the fitting and eventual fracture to cause water damage to your property.
- The faucet was tested and meets ASME/ANSI code on its operation, loading and torque pressure. However this faucet is not designed to support weight over 250 pound per square inch of pressure, **DO NOT OVERTIGHTEN.** **DO NOT APPLY ELECTRICAL TOOL** to fasten faucet installation.
- For Exposed tub supply line installation faucet model, your supply lines have to be installed on corner area, or at area with no walking traffic access to cause accidental tamper or accidental breakage. For installation of exposed supply line at open traffic area is prohibited.
- Removal of this tag prior to installation will void your warranty. Pass the WARNING TAG to the owner after installation.



KINGSTON

KITCHEN & BATH

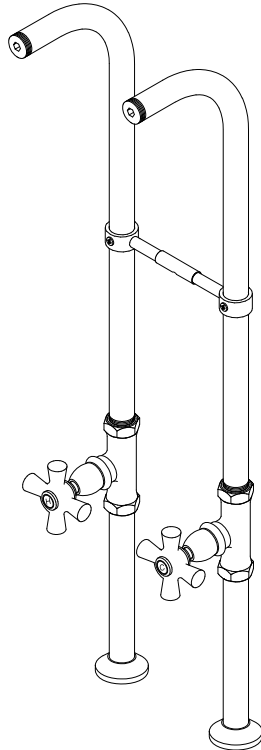
Free standing supply lines Installation



Parts:

Lock Nut	Washer & Coupling Nut	Washer
		
4 Pcs	2 Pcs	2 Pcs

www.kingstonbrass.com
 TOLL-FREE CUSTOMER SERVICE: 1-877-2-KBRASS
 TECHNICAL SUPPORT E-mail: service@kingstonbrass.com
 12775 Reservoir Street, Chino, CA 91710

This item is designed to be installed in wood floors. If you have a concrete floor it may be necessary to build a platform to accommodate the inlet connections refer to image on right.

Before starting the installation of your supply lines you should:

- Verify the center to center of your faucet and rough in your supply lines accordingly, flush lines to clear any debris left in the line.
- Allow a 6" minimum clearance below the floor to allow sufficient space for attachment of the supply lines to the intended stub out.
- Drill 1" holes at the rough in location.
- We recommend that you install 3/4" brass floor flanges (not included) from below as an extra support.

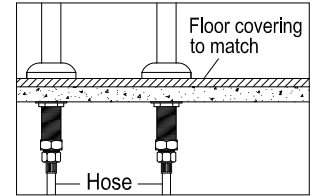

Installation Steps:

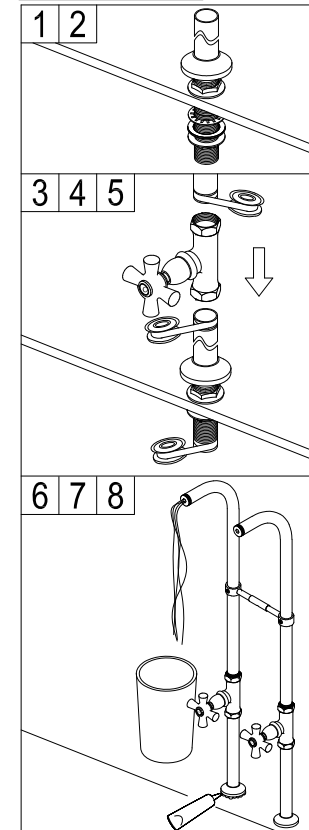

1. Insert horizontal bracket into the bottom of the 2 top risers, slide up to the desired level and tighten screws, insert flange on bottom risers.
2. Apply Teflon tape to both ends of the top riser as well as to the top portion of the lower riser.
3. Thread shut-off valve to bottom of top riser and to top portion of lower riser, make sure that the handles on the shut-off valve point in the same direction.
4. Thread locknut to the top of the bottom threads of the lower riser and insert through the pre-drilled holes on the floor, thread on brass floor flange if you elected to install one under your floor.
5. Insert rubber washer and metal washer on the bottom riser, thread locknut and secure both supply lines from below the floor.
6. If your inlet supplies stub-outs are 3/4" apply Teflon tape and thread your intended water supplies, if your inlet supply stub-outs are 1/2" apply Teflon tape to the bottom of lower riser and thread 1/2" adapter (included) apply Teflon tape to 1/2" threads on adapter and thread on your supply stub out.
7. From above the floor apply a bead of silicon based caulking to the bottom of the flange and press to the floor to form a water proof barrier.
8. While holding a bucket at the outlet of the supply lines, open each valve and let water run for 30 seconds, check for leaks.

Warning!!!

Reshaping, bending or altering supply line or use of nuts or washers not supplied with this kit will void your warranty.
 Please do not pull or lean on the faucet once it has been installed, this may bend or pull the supply line which may cause a leak resulting in possible water damage.

Installer:

Please pass this installation manual to homeowner after installation. ©2019-10-TL Kingston Brass